

by Avantechs, Inc.

VorBlade™ Cab or Trailer System

VorBlade Invisible Shield. Feel the difference. Share your experience.

www.vorblade.com 303-HIGHWAY (303-444-4929)

INSTALLATION GUIDE

Please, read this Guide carefully before installation. Please note that modification of the installation pattern such as changing orientation of VorBlade™ vortex generators or placing the generators closer to each other could degrade the VorBlade™ performance or result in unexpected side-effects. Avantechs Inc. takes no responsibility for installation procedures different from the ones specifically provided for the VorBlade™ products.

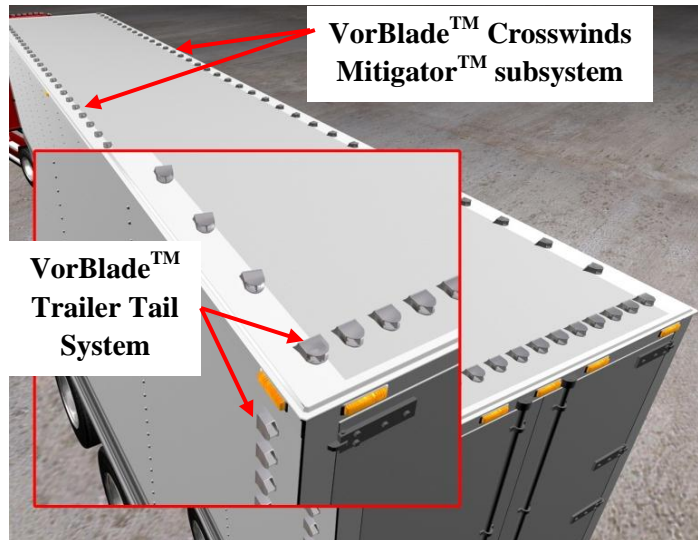

VorBlade™ Systems on a typical cab and a typical trailer: VorBlade™ vortex generators on the rear of a cab, on the rear of a trailer, and on the side edges of a trailer roof

VorBlade™ Cab or Trailer Tail System consists of a set of VorBlade™ vortex generators to be mounted on a cab or a trailer tail. Usually 48 generators are enough for a typical cab and from 48 to 54 generators are needed for a typical 102” wide trailer.

*Please see the **VorBlade™ Crosswinds Mitigator™ subsystem installation guide** for installation instructions of VorBlade™ vortex generators on side edges of a trailer roof. Installation Guides for all VorBlade™ products can be found at our website www.VorBlade.com on the “Products” page.*

Installation conditions: attaching VorBlade™ vortex generators to a vehicle must be performed from a trailer bay, scaffold, rolling ladder or other appropriate platform providing stable, non-slippery and otherwise safe support to the personnel performing the installation. Please note that the generators are to be attached to a vehicle at the height up to 14 ft above the ground.

Please install VorBlade™ vortex generators on your vehicle in dry environment at temperatures between 50°F and 110°F to guarantee the bond strength. Please let the adhesive to settle: the full bond strength of the adhesive pads occurs in 24 to 48 hours.

For installation video and additional information please visit www.vorblade.com, click on “How it works?” then click further on “How many do I need? Where do they go?” and watch the provided video if needed.

Packing list - please check received parts against the list and identify each part as it is unpacked:

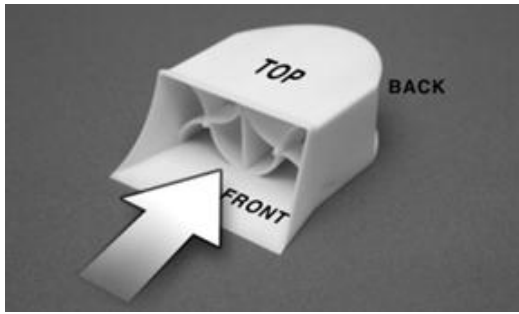

VorBlade™ vortex generators, 48 per box

All boxes with VorBlade™ vortex generators have circular color marks outside. A color of the mark indicates the color of the generators inside the box. A standard Cab or Trailer Tail System includes 48 VorBlade™ vortex generators each.

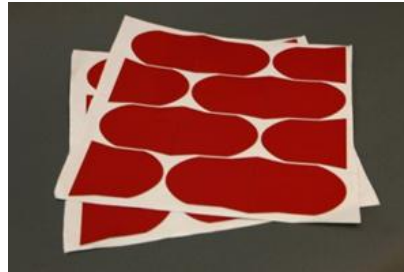

Double-sided adhesive pads, 4 sheets (48 pads) per box

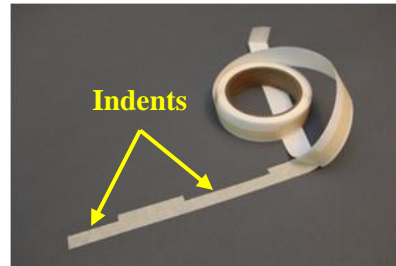

Installation template tape, 1 roll per box (32 ft per roll)

Installation of VorBlade™ vortex generators on a cab and/or a trailer tail

Step 1: Attaching double-sided adhesive pads to the bottom surface of the VorBlade™ vortex generators



1a: Clean the bottom surface of the generators by standard cleaning solvents such as 50/50 mixture of Isopropyl Alcohol with water, wax and grease removers and the like (not included).

1b: Wipe surfaces dry with cloth or paper towels.

1c: Peel adhesive tape pad from the liner sheet.

1d: Attach firmly adhesive pad to the generator starting from the front.

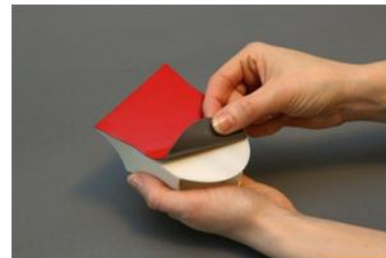

1e: Set generators aside for 15 min or more to set the bond.

Step 2: Finding the appropriate positions for the VorBlade™ Cab or Trailer Tail System

Cabs and trailers are different and “optimal” positions of VorBlade™ vortex generators for your vehicle depend on the vehicle’s configuration. To ensure the best performance of VorBlade™ generators, it is preferable to attach them as close to the rear edge of a cab or a trailer as possible. However the performance of the system does not degrade significantly when the VorBlade™ vortex generators are positioned up to 1ft from the rear edge of your vehicle.

VorBlade™ vortex generators must be installed on a flat metal or painted surface. Do NOT install the generators on the top of rivet heads or on non-approved surfaces including but not limited to rubber fairings, rough fiberglass surfaces, any flexible or non-flat spots and the like.

2a. Inspect the rear edges of your cab trailer and find such positions for VorBlade™ vortex generators that ensure the best fit to your vehicle - the “optimal positions” for your cab or trailer. Measure the distances from the FRONT of generators to the rear edges of the vehicle to establish “optimal distances”. Those “optimal distances” for your vehicle must be from 4-1/4” to 16”.

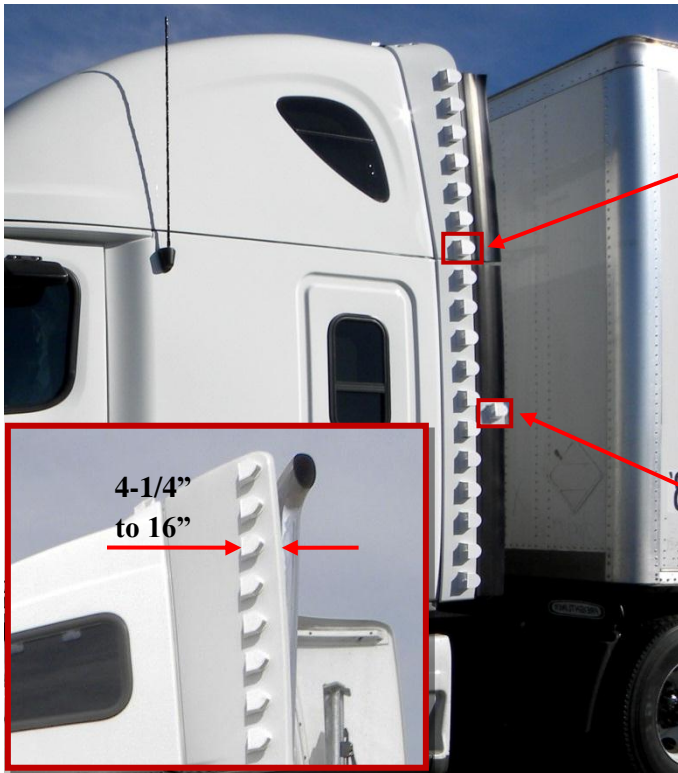

Correct position(s)

Incorrect position(s)

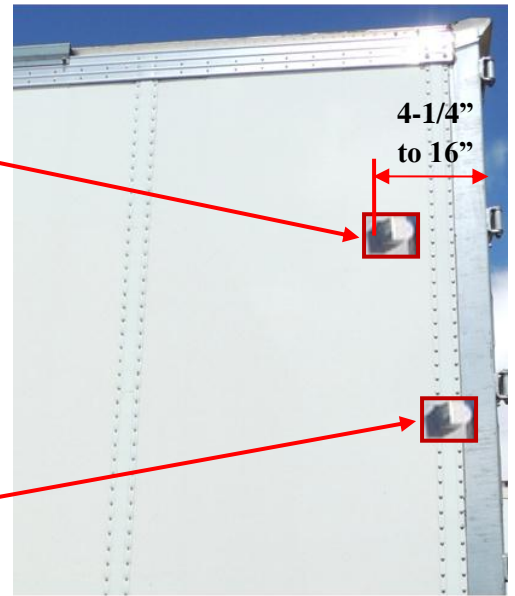

The “optimal distance” from the FRONT of VorBlade™ vortex generators to the rear edges of your cab or trailer must be from 4-1/4” to 16”.

VorBlade™ generators on a roof and on side walls of a cab or a trailer shall not be necessary positioned along a straight line. The generators on a roof may also be positioned at a different distance from the rear vehicle edge than the generators on side walls.

If any obstacles on the surface like rivet heads, seams, ribs and the like prevent attaching the generators on a roof or side walls of your cab or trailer along a line, one or several generators may be moved back or forth up to 2” with respect to others.

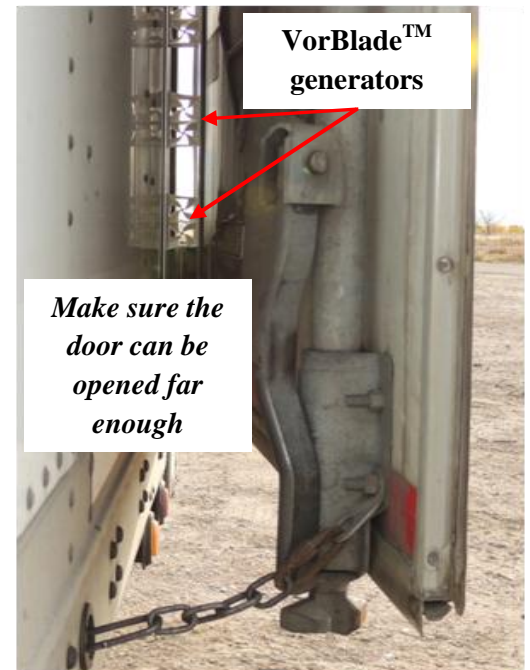
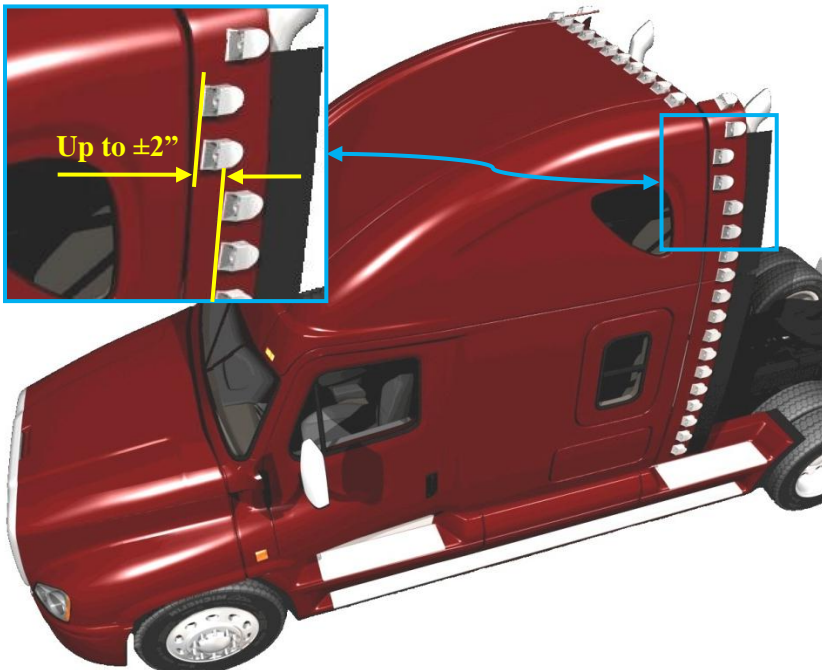

Warning for the VorBlade™ Trailer Tail System: Make sure that the trailer doors can be opened far enough for normal trailer operations when positioning the generators on the side walls of a trailer. Besides the door frame of some trailers sticks up more than 1" above the roof level which can potentially interfere with the generated vortices. In order to ensure the best performance of VorBlade™ generators on a trailer roof in such cases, position the back of generators at least 4" ahead from the door frame.

2b: Check carefully the chosen generator positions on a cab or a trailer roof and side walls: the distance from the front of VorBlade™ generators to the vehicle rear edge is from 4-1/4" to 16", generators are positioned on a flat metal or painted surface and (for the Trailer Tail System) the trailer doors may be opened far enough.

2c: Once the appropriate positions are established, measure the distances from the FRONT of VorBlade™ generators to the vehicle rear edges. The established "optimal distances" are to be used for positioning installation templates in Step 4 and attaching the generators in Step 5. The "optimal distances" for the roof and sidewalls might be different.

Step 3: Cleaning and degreasing vehicle surfaces for attaching the generators

3a: Clean the vehicle surfaces at locations selected in Step 2 for attaching VorBlade™ vortex generators. Use standard cleaning solvents such as 50/50 mixture of Isopropyl Alcohol with water, wax and grease removers and the like.

3b: Wipe surfaces dry with cloth or paper towels.

Warning: Be sure to clean and dry the surface carefully - adhesive pads do not provide strong bond on wet, greasy or otherwise dirty surfaces.

Step 4: Positioning installation templates on a cab and/or a trailer tail

If the "optimal distances" established in Step 2 are not the same for different surfaces of your vehicle or/and some of generators were moved back or forth with respect to others, cut installation templates into separate pieces of the required length.

4a: Attach the installation templates to the rear edges of a cab or trailer at the "optimal distances" from the rear of your vehicle established in Step 2. **The indents in the templates must be oriented towards the back of a vehicle.** Make sure that the distance from the rear of a template to the rear vehicle edge is between 4-1/4" and 16" (the length of the VorBlade™ generator is 4").

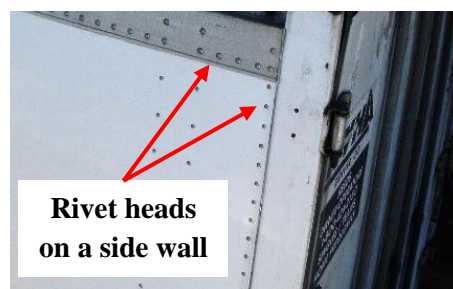
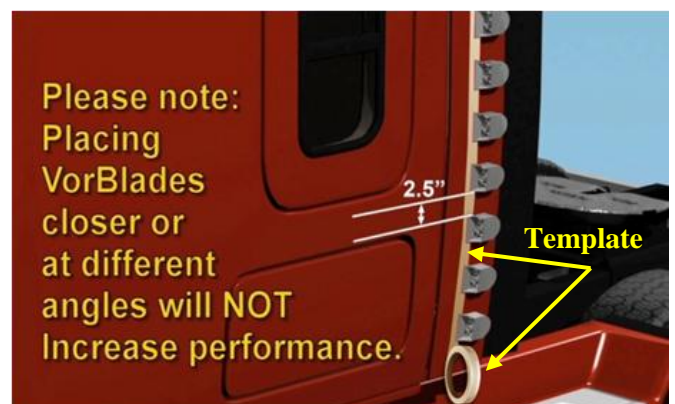
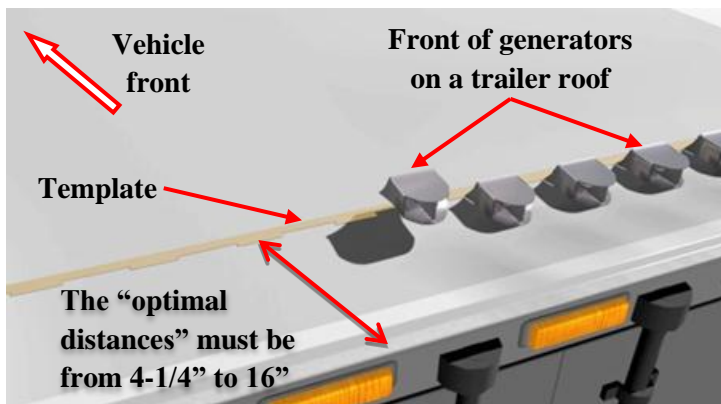

Warning: please do not place the bottom surfaces of the generators over rivet heads or other obstacles. If the vehicle surface is not smooth, either move the generator slightly away from the rear edge or put a few adjacent generators slightly closer to one another than recommended by the template.

Step 5: Attaching VorBlade™ generators to a cab and/or a trailer tail

5a. Count the indents on the installed template and establish a number of generators needed for your cab or trailer tail. In some cases more generators could be installed on a vehicle that is included in the standard set. If this is the case for your vehicle, please start from the top and continue downwards. There may be up to about a foot-high empty space left in the bottom which does not affect significantly performance of the VorBlade™ system due to the ground effect.

In the case it is preferable to fill the empty spaces for better appearance or the maximum performance, you may order additional generators required for your cab and/or trailer.

5b: Peel protective liner from the adhesive tape on the bottom of generators.

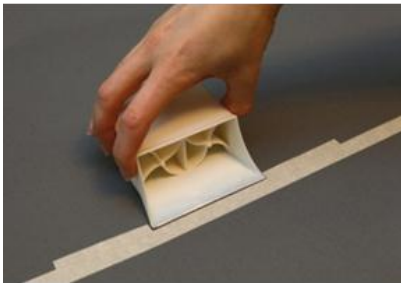
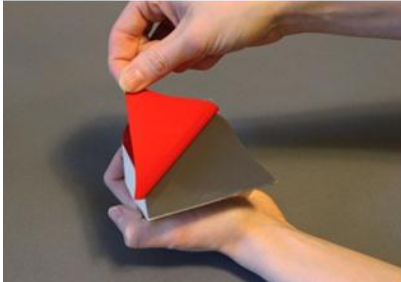

Standard Cab or Trailer Tail System includes 48 VorBlade™ vortex generators each. If your cab/ trailer tail have a larger capacity, please attach the generators from the top to the bottom symmetrically on the driver and passenger sides of a vehicle.

Up to
about
1 ft

VorBlade™ vortex generators are identical and can be interchanged, i.e. cab generators may be used for a trailer and vice versa.

5c: Set the front bottom edge of a generator at the template's indent and align the generator parallel to the vehicle centerline or longitudinal edges - **the front of generators must be oriented towards the front of a vehicle.**

5d: Lower the generator and push firmly to the surface.

Step 6: Finishing the installation

6a: Remove the installation templates.

6b: Do not drive the vehicle for several hours allowing the adhesive to build-up the bond strength. *The full bond strength of adhesive pads occurs in 24 to 48 hours.*

Please note: VorBlade™ Cab or Trailer Tail System does not require a periodic maintenance. Nevertheless, due to deviations from the installation procedures, harsh vibrations, unforeseen mechanical impacts, extended exposure to adverse weather conditions, or any misuse of the VorBlade™ vortex generators, adhesives might lose bond strength. The system must be inspected visually every 2 months for the adhesives that might be losing the strength or any mechanical damage and the detected problems must be fixed. It is the sole responsibility of the user to maintain the VorBlade™ products in safe and fully operational condition.

DISCLAIMERS

The enclosed double-sided adhesive pads will adhere well to most clean and dry vehicle surfaces. However, the pads may not be the best option for some surfaces such as raw rough-textured fiberglass or non-flat surface. Please contact our customer support for specific instructions.

Any installation of VorBlade™ product is subject to the terms and conditions of use posted on the company's website. The Buyer/Installer understands and agrees that these terms and conditions shall apply to any and all orders/installations of VorBlade™ products placed or performed at any time by the Buyer and/or Installer.

Avantechs Inc. does not warrant that products are suitable for all uses and operations on all truck, trailer, or vehicle models. It is the sole responsibility of the buyer and/or installer to determine product compatibility and ensure usage safety. Avantechs Inc. is not responsible for any injuries, damages to trucks, trailers or other vehicles including third party vehicles due to installation and/or use of the product. Avantechs Inc. is not liable for non-compliance with any local or state regulations. It is the sole responsibility of the buyer to establish his vehicle(s) or fleet compliance.

Avantechs Inc. is not responsible for traumas or injuries occurred during the installation due to the use of unstable, slippery or otherwise inappropriate platform, unskillful or otherwise inappropriate use of installation tools, violation of safety instructions for the applied manual or powered tools, or other violations of the standard safety rules and instructions.

Modification of the installation procedures may result in the VorBlade™ vortex generators being torn from a trailer which in turn may lead to serious crushing injuries. Avantechs, Inc. takes no responsibility for installation procedures different from the ones specifically provided for the VorBlade™ products.